

GIA COLORED DIAMOND REPORT

May 19, 2014  
 Report Type ..... Grading Report  
 GIA Report Number ..... 2165111529  
 Shape and Cutting Style ..... Cushion Modified Brilliant  
 Measurements ..... 5.86 x 5.37 x 3.79 mm  
  
 Carat Weight ..... 1.15 carat  
 Color Grade ..... Fancy Yellow  
 Color Origin ..... Natural  
 Color Distribution ..... Even  
 Clarity Grade ..... VVS2  
 Proportions:

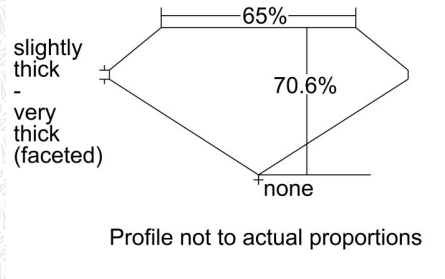



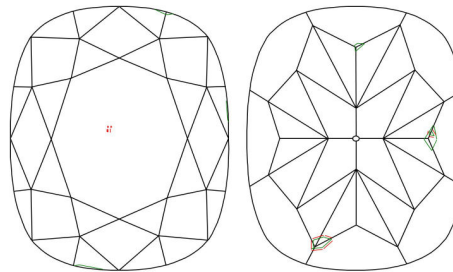

Polish ..... Very Good  
 Symmetry ..... Very Good  
 Fluorescence ..... Faint

ADDITIONAL INFORMATION

CLARITY CHARACTERISTICS



KEY TO SYMBOLS\*

-  Needle
-  Pinpoint
-  Indented Natural
-  Natural

\* Red symbols denote internal characteristics (inclusions). Green or black symbols denote external characteristics (blemishes). Diagram is an approximate representation of the diamond, and symbols shown indicate type, position, and approximate size of clarity characteristics. All clarity characteristics may not be shown. Details of finish are not shown.

GIA COLORED DIAMOND SCALE

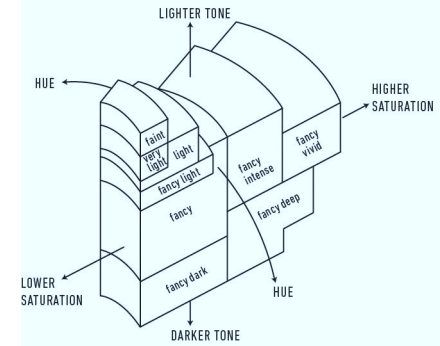

Illustration of GIA fancy color grade interrelationships

GIA CLARITY SCALE

VERY VERY SLIGHTLY INCLUDED	FLAWLESS
	INTERNALLY FLAWLESS
VERY VERY SLIGHTLY INCLUDED	VVS <sub>1</sub>
	VVS <sub>2</sub>
VERY SLIGHTLY INCLUDED	VS <sub>1</sub>
	VS <sub>2</sub>
SLIGHTLY INCLUDED	SI <sub>1</sub>
	SI <sub>2</sub>
INCLUDED	I <sub>1</sub>
	I <sub>2</sub>
	I <sub>3</sub>



[reportcheck.gia.edu](http://reportcheck.gia.edu)



The results documented in this report refer only to the diamond described, and were obtained using the techniques and equipment used by GIA at the time of examination. This report is not a guarantee or valuation. For additional information and important limitations and disclaimers, please see [www.gia.edu/terms](http://www.gia.edu/terms) or call +1 800 421 7250 or +1 760 603 4500. ©2014 Gemological Institute of America, Inc.

 THE SECURITY FEATURES IN THIS DOCUMENT, INCLUDING THE HOLOGRAM, SECURITY SCREEN AND MICROPRINT LINES, IN ADDITION TO THOSE NOT LISTED, EXCEED DOCUMENT SECURITY INDUSTRY GUIDELINES.