

**GIA COLORED DIAMOND REPORT**

October 15, 2018

Report Type ..... Grading Report

GIA Report Number ..... 6192712514

Shape and Cutting Style ..... Oval Modified Brilliant

Measurements ..... 6.26 x 4.51 x 2.82 mm

Carat Weight ..... 0.61 carat

Color Grade ..... Fancy Yellowish Green

Color Origin ..... Natural

Color Distribution ..... Even

Clarity Grade ..... SI1

Proportions:

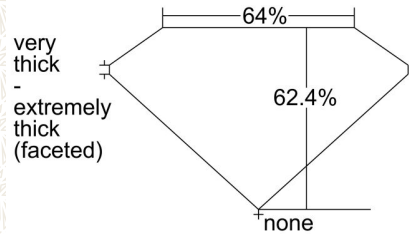

Profile not to actual proportions

Polish ..... Good

Symmetry ..... Fair

Fluorescence ..... Medium Blue

Inscription(s): GIA 6192712514

**Comments:** An additional twinning wisp, clouds, pinpoint, patches of color and surface graining are not shown.







**ADDITIONAL INFORMATION**
**GIA COLORED DIAMOND SCALE**

Illustration of GIA fancy color grade interrelationships

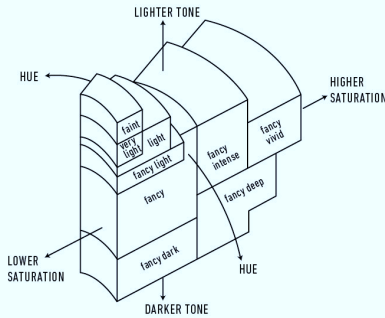
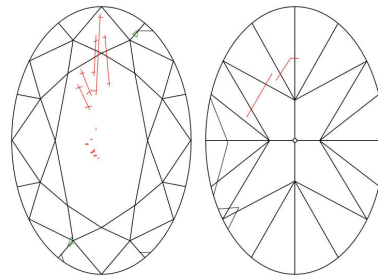
**GIA CLARITY SCALE**

FLAWLESS
INTERNALLY FLAWLESS
VVS <sub>1</sub>
VVS <sub>2</sub>
VS <sub>1</sub>
VS <sub>2</sub>
SI <sub>1</sub>
SI <sub>2</sub>
I <sub>1</sub>
I <sub>2</sub>
I <sub>3</sub>

**CLARITY CHARACTERISTICS**

**KEY TO SYMBOLS\***

-  Twinning Wisp
-  Feather
-  Crystal
-  Needle
-  Natural
-  Extra Facet

\* Red symbols denote internal characteristics (inclusions). Green or black symbols denote external characteristics (blemishes). Diagram is an approximate representation of the diamond, and symbols shown indicate type, position, and approximate size of clarity characteristics. All clarity characteristics may not be shown. Details of finish are not shown.

[reportcheck.gia.edu](http://reportcheck.gia.edu)

 The results documented in this report refer only to the diamond described, and were obtained using the techniques and equipment used by GIA at the time of examination. This report is not a guarantee or valuation. For additional information and important limitations and disclaimers, please see [www.gia.edu/terms](http://www.gia.edu/terms) or call +1 800 421 7250 or +1 760 603 4500. ©2014 Gemological Institute of America, Inc.

 THE SECURITY FEATURES IN THIS DOCUMENT, INCLUDING THE HOLOGRAM, SECURITY SCREEN AND MICROPRINT LINES, IN ADDITION TO THOSE NOT LISTED, EXCEED DOCUMENT SECURITY INDUSTRY GUIDELINES.